

DESCRIPTION

Lubriquip's Trabon Cycle Proximity Switches are used for providing a signal to a Monitor, Controller or Programmable Logic Controller (PLC) to indicate the number of cycles and cycle rate of a Series-Progressive (SP) divider valve; this signal is transmitted via a feedback loop to the Controller, providing the status of the lubrication cycle it is programmed to monitor and record.

Lubriquip offers three types of proximity switches for use on Series-Progressive divider valves: Reed-Type (Reed) Proximity Switch, Field Sensing Magnetic (FSM) Proximity Switch, and Field Sensing Mechanical (FS_{mech}) Proximity Switch. All are magnetically operated, single-throw switches that sense the movement of the divider valve's piston when it is cycling.

The Reed-Type proximity switch is available as an unattached version (magnetically attached to piston) for oil-only applications using MSP, MH or MGO divider valve assemblies.

The Field Sensitive Magnetic proximity switch is a dry contact, ceramic magnet operated switch. It can be used in either grease or oil applications and is available in three sizes compatible with MSP, MH, MX/MXP, and MGO assemblies and its use is not limited by valve section size. This switch is also available in an explosion-proof design with a six-foot long cable for use in MS/MH divider valves.

The FS_{mech} proximity switch is designed to provide a greater reliability of operation when used with the very low signal power conditions common to DC-powered PLC's. It is a magnetically activated proximity switch that contains a miniature snap-action switch, activated by the attraction of its internal magnet to the divider valve's moving piston. The 24 volt DC-only version of this switch is available with integral light-emitting diodes (LED) for local verification of power and cycling activity. Similar designs without LED's are suitable for either AC or DC power operation; there is also an explosion-proof version with six foot long pigtail leads. FS_{mech} proximity switches are available for MSP, MH, and MX/MXP divider valve assemblies.

Each type of Lubriquip Proximity Switch is available with a variety of customer-required options to fulfill each of their application's particular specifications: 24 VDC or 115 VAC power, LED cycle indicator lights for DC applications, and various types of electrical connection options: Brad Harrison or Crouse Hinds cables with either 3,4, or 5 pin connectors, 6 ft., 3-wires (for explosion-proof versions), or ½" NPT conduit (Reed Switch types only).

A complete list of the cycle and proximity switches with their available options appears on Page 2.

OPERATION

Proximity Switches are installed in place of a piston enclosure plug in one of the working sections of a Series-Progressive divider valve assembly. They are actuated by movements of the lube-dispensing piston inside the section and thereby send a signal to the Controller indicating the rate and amount of activity of the proportioning divider as lubricant is pumped through it.

Reed type switches utilize a pin attached magnetically to a piston to cause the switch contacts to close. Field sensing magnetic type of switches sense the proximity of the pistons' mass to cause contact closure. When the piston moves in the opposite direction away from the switch, the Reed switch is deactivated by the withdrawal of the actuating pin and opens its contacts. Similarly, the FSM Proximity Switch's sensing of the piston is lost and it's contacts open. The two contact transitions (open-to-closed and closed-to-open) are detected by the Monitor/Controller, which has been programmed to interpret such a signal as one complete cycle of the divider section, and therefore one complete cycle of the entire SP divider valve assembly.

Depending upon the individual lubrication system's design and lubrication requirements, the Controller or PLC programming then uses the feedback signals from the Proximity Switch in each lubrication zone to start and stop the lubrication cycle periodically as required by the system design specifications. If the Controller or PLC does not receive the expected signal within a time period specified in the lubrication system's design, and programmed into the PLC as the "Monitor Time", the PLC can initiate various responses as specified by the user. These responses can include triggering a local audible and/or visual warning or sending an electronic notification to a remote computer terminal.

Modular Divider Type	Proximity Switch Part No.	Prox. Switch Type	Operating Voltage	Cable Electric Connection	LED	Max. Cycle Rate Per Min.	Max. Pressure Rtg - psi	Rated Life - Cycles
MGO	UL+CSA 527-007-120	FSM	20-28 VDC	4-pin CH Mini	No	60	10,000**	150,000,000+
MGO	UL+CSA 527-007-160	FSM	115 VAC	5-pin BH Mini	No	60	10,000**	150,000,000+
MGO	570-155-001	Reed	115 VAC	1/2" NPT cond	No	60	7,500	10,000,000+
MGO	UL+CSA 570-999-060	FSM	115 VAC	3-pin BH Mini	No	200	3,500	150,000,000+
MGO	UL+CSA 570-999-220	FSM	115 VAC	5-pin BH Mini	No	200	3,500	150,000,000+
MXP/MX/MXO	UL+CSA 527-005-190	FSM	115 VAC	5-pin BH Mini	No	200	3,500	150,000,000+
MXP/MX/MXO	UL+CSA 527-005-520	FSM	115 VAC	3-pin BH Mini	No	200	3,500	150,000,000+
MXP/MX/MXO	527-006-130	FS _{mech}	12-32 VDC	3-pin BH Mini	Yes	150	7,500	10,000,000+
MXP/MX/MXO	527-006-140	FS _{mech}	12-32 VDC	5-pin BH Mini	Yes	150	7,500	10,000,000+
MXP/MX/MXO	CSA _{NRTL} 527-006-150	FS _{mech}	AC or DC	Expl Proof *	No	150	7,500	10,000,000+
MXP/MX/MXO	UL+CSA 527-007-110	FSM	20-28 VDC	4-pin CH Mini	No	60	10,000**	150,000,000+
MXP/MX/MXO	UL+CSA 527-007-140	FSM	115 VAC	5-pin BH Mini	No	60	10,000**	150,000,000+
MSP/MH	UL+CSA 527-003-251	FSM	115 VAC	3-pin BH Mini	No	200	3,500	150,000,000+
MSP/MH	⚡ 527-003-431	FSM	115 VAC	Expl Proof *	No	200	3,500	150,000,000+
MSP/MH	UL+CSA 527-004-111	FSM	115 VAC	5-pin BH Mini	No	200	3,500	150,000,000+
MSP/MH	UL+CSA 527-004-112	FSM	12-32 VDC	4-pin CH Mini	No	200	3,500	150,000,000+
MSP/MH	527-005-670	FS _{mech}	12-32 VDC	5-pin BH Mini	Yes	150	7,500	10,000,000+
MSP/MH	527-005-690	FS _{mech}	12-32 VDC	3-pin BH Mini	Yes	150	7,500	10,000,000+
MSP/MH	527-006-050	FS _{mech}	AC or DC	5-pin BH Mini	No	150	7,500	10,000,000+
MSP/MH	CSA _{NRTL} 527-006-060	FS _{mech}	AC or DC	Expl Proof *	No	150	7,500	10,000,000+
MSP/MH	527-001-231	Reed	AC or DC	1/2" NPT cond	No	60	7,500	10,000,000 +
MSP/MH	527-007-263	FS _{mech}	12-32 VDC	4-pin BH Micro	Yes	150	7,500	10,000,000+

UL + CSA = Approved

CSA_{NRTL} = Approved for hazardous locations: Class I, Groups A, B, C, & D - Division 1

⚡ = UL and CSA approved for hazardous locations:

Class I, Groups A, B, C, & D - Division 1
Class II, Groups E, F, & G - Division 1.

*Includes 6ft., 3 conductor cable.

**Specially developed and recommended for stamping press applications.

NOTE: Cycle Indicator Proximity Switches shown in this bulletin are for use in divider valves having O-ring sealed piston closure ports only. Contact factory for availability of crush gasket equipped units used in older crush gasket sealed dividers.

TRABON® REED TYPE PROXIMITY SWITCHES

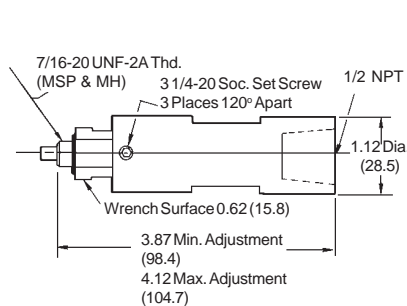

Figure 1 Model 527-001-231
Used on MH, MSP
Divider Valves

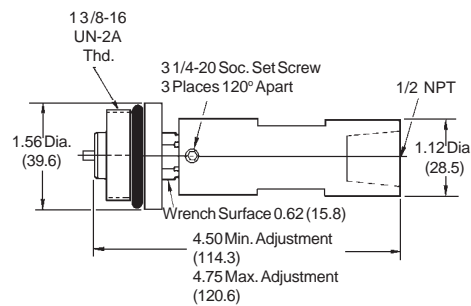
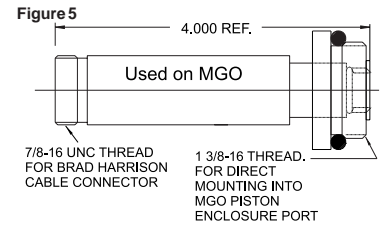
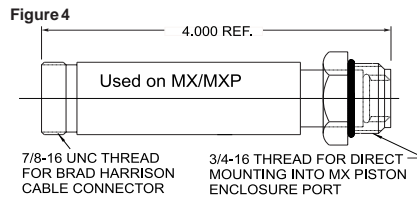
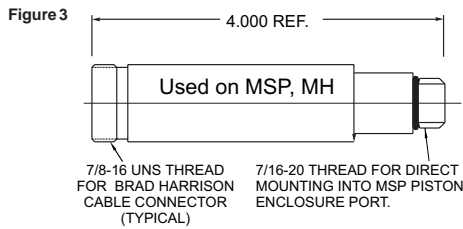

Figure 2 Model 570-155-001
Used on MGO Divider Valves

SPECIFICATIONS

Material: Alum HSG, SS Magnet HSG, Buna-N O-Ring
Electrical: 0.5A @ 50VDC, 10mA @ 115VAC, N.O.
Lubricant: Oil only
Max. Cycle Rate: 60 cpm
Temp. Range: -20°F to 180°F (-29°C to 83°C)
Max. Pressure: 7500 psi

TRABON® FSM -TYPE PROXIMITY SWITCHES - 3 PIN, 4 PIN, 5 PIN, EXPL. PROOF



TYPICAL PIN-OUT DIAGRAMS

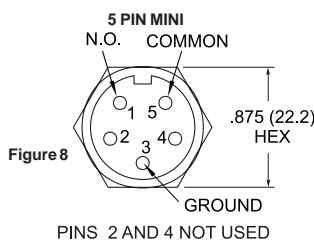
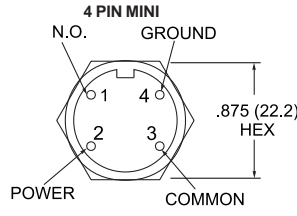
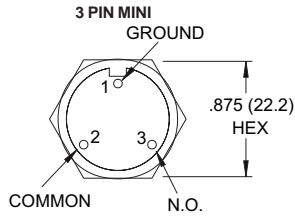

Explosion Proof
Refer to bottom of Page 4.

SPECIFICATIONS

Material: Type 303 SS Housing, Buna-N O-Ring
 Electrical: 3 & 5 Pin 2A @ 120/240 VAC, N.O.
 4 Pin 0.1A @ 20-28VDC, N.O.
 Lubricant: Oil or Grease
 Max. Cycle Rate: 3 & 5 Pin 200 cpm, 4 Pin 60 cpm
 Temp. Range: -22°F to 250°F (-30°C to 121°C)
 Max. Pressure: (See Table)

TRABON® FS_{MECH} -TYPE PROXIMITY SWITCHES - 3 PIN, 4 PIN, 5 PIN, EXPL. PROOF

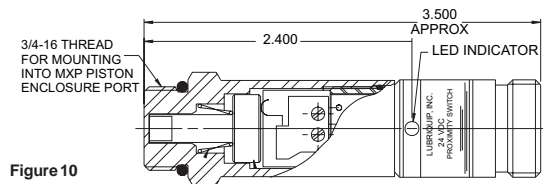
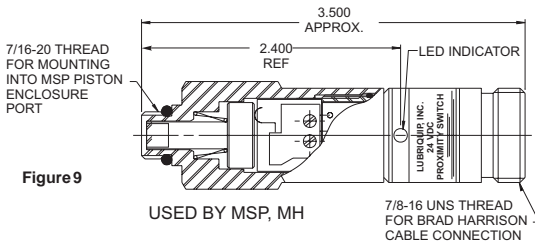

TYPICAL PIN-OUT DIAGRAMS

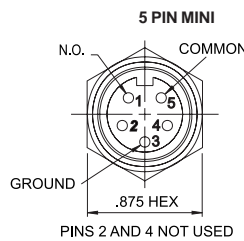
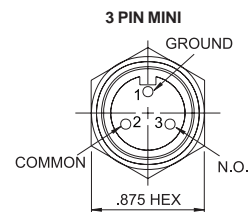

Explosion Proof
Refer to bottom of Page 4.

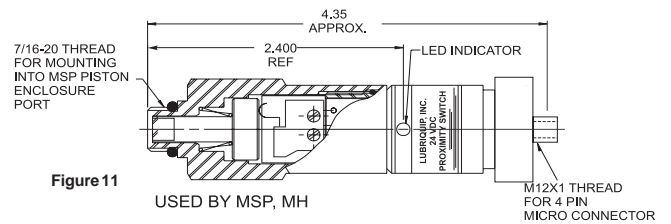

Figure 12

Figure 13

SPECIFICATIONS

Material: Type 303 SS Housing, Viton O-Ring
 †Electrical: With LEDs 3A @ 28VDC, N.O.
 Without LEDs 1.2VA @ 28 VDC, 5A @ 115/230 VAC, N.O.
 Lubricant: Oil or Grease
 Max. Cycle Rate: ... 150 cpm (See rated life cycles in table)
 Temp Range: -58°F to 167°F (-50°C to 75°C)
 Max. Pressure: 7500 PSI

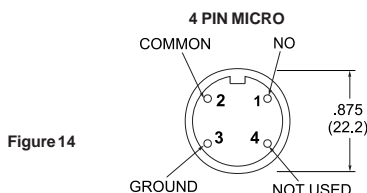

Figure 14

† The FS_{mech} Illuminated Proximity Switches (i.e. 527-005-670) are designed to work with controllers and PLCs which have a typical input impedance of 1500 ohms or less. Using the switch on devices which have an input impedance about 3000 ohms or larger may cause the input to not recognize a change of state to the closed position. If using a high impedance input, it is suggested that a 527-006-050 non illuminated FS_{mech} switch be used. If state indication is required, a connecting cable with LEDs should be used.

ACCESSORIES - CABLES

Lubriquip offers a variety of connecting cables for use with its proximity switches. Cables are available with either straight or right-angle Mini, or Micro connectors; with or without indicator lights and in lengths from three to twelve feet as listed in the tables below.

DC PROX. SWITCH CABLES - 4 PIN
(MINI CONNECTOR 7/8-16 TH'D)

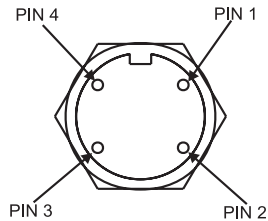

4-PIN CABLE OPTIONS For DC-Powered Applications with LED Power/Operational Indicators			
Connector	Polarity	Lubriquip Part Number	Cable Length
Straight	NPN	570-999-937	12 ft
90°	NPN	570-999-938	12 ft
Straight	PNP	570-999-953	12 ft
90°	PNP	570-999-954	12 ft

CABLE WIRES COLOR CODE: EURO	DC CABLE PIN ASSIGNMENTS	
	PNP Cable*1 (with LED Operational Indicators)	NPN Cable*2 (with LED Operational Indicators)
Black	Pin 1 - N.O.	Pin 1 - N.O.
Blue	Pin 3 - Common	Pin 2 - Common
White	Pin 4 - Ground	Pin 4 - Ground
Brown	Pin 2 - Power	Pin 3 - Power

* 1 = Sourcing
* 2 = Sinking

AC & DC PROX. SWITCH CABLES - 5 PIN
(MINI CONNECTOR 7/8-16 TH'D)

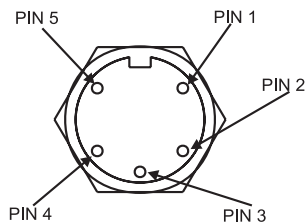

5-PIN CABLE OPTIONS for AC or DC-Powered Applications (No Operational Indicators in Cables)		
Connector	Lubriquip Part Number	Cable Length
Straight	570-999-180	3 ft
Straight	570-999-160	6 ft
Straight	570-999-170	12 ft
90°	570-999-390	6 ft

USA COLOR CODES	AC CABLE PIN ASSIGNMENTS
White	Pin 1 - N.O.
Red	Pin 2 - Not Used
Green	Pin 3 - Ground
Orange	Pin 4 - Not Used
Black	Pin 5 - Common

AC & DC PROX. SWITCH CABLES - 3 PIN
(MINI CONNECTOR 7/8-16 TH'D)

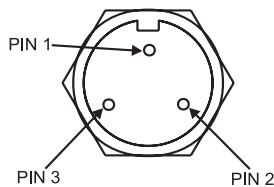

3-PIN CABLE OPTIONS for AC or DC-Powered Applications (No Operational Indicators in Cables)		
Connector	Lubriquip Part Number	Cable Length
Straight	570-999-070	3 ft
Straight	570-999-080	6 ft
Straight	570-999-090	12 ft

USA COLOR CODES	AC CABLE PIN ASSIGNMENTS
Green	Pin 1 - Ground
Black	Pin 2 - Common
White	Pin 3 - N.O.

DC PROX. SWITCH CABLES - 4 PIN
(MICRO CONNECTOR M12X1 THREAD)

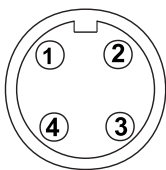

Color Codes	DC CABLE PIN ASSIGNMENT
Brown	Pin 1 - N.O.
White	Pin 2 - Common
Blue	Pin 3 - Ground
Black	Pin 4 - Not Used

4-PIN CABLE OPTIONS for DC-Powered Applications		
Connector	Lubriquip Part Number	Cable Length
Straight	570-999-590	6.6 ft
90	570-999-600	6.6 ft

EXPLOSION-PROOF PROXIMITY SWITCHES

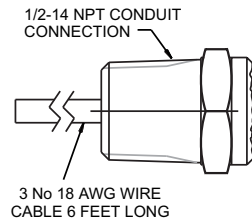

Part Number	Wire Color For		
	Common	Normally Open	Ground
527-003-431	Black	Blue or White	Red
527-006-060	Black or Red w/Black Stripes	White or Red w/White Stripes	Green
527-006-150	Black or Red w/Black Stripes	White or Red w/White Stripes	Green

ISO 9000:2000 REGISTERED FIRM ISO 14001 REGISTERED FIRM

® Registered trademark of LUBRIQUIP, INC.,
A Unit of IDEX Corporation, Printed in U.S.A.